



INSTALLATION INSTRUCTIONS

Accessory	Application	Publications No.
FENDERWELL TRIMS P/N 08P21-S5D-100	2001-2005 CIVIC 2- AND 4-DOOR	All 27862
		Issue Date
		AUG 2004

PARTS LIST

Left front fenderwell trim

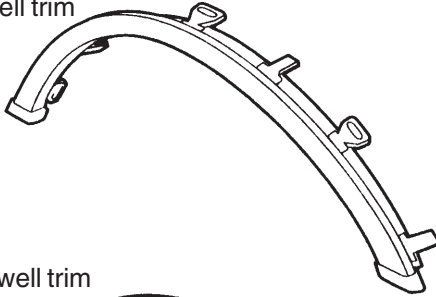

Right front fenderwell trim

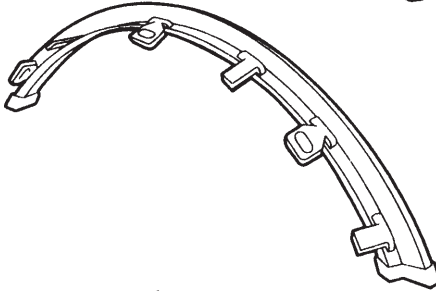

Left rear fenderwell trim

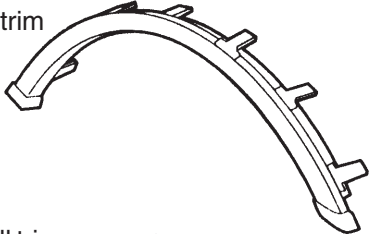

Right rear fenderwell trim

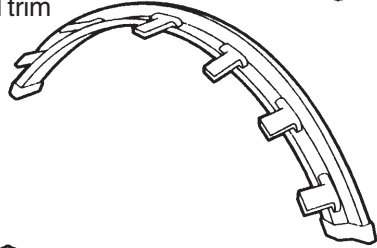

2 Inner protectors

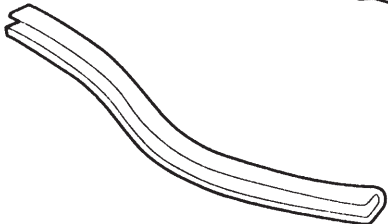

TOOLS REQUIRED

- Flat-tip screwdriver
- Pliers
- Rubber mallet
- Shop towel

INSTALLATION

NOTE:

- These instructions show the right fenderwell trims being installed; the same procedure applies to installing the left fenderwell trims.
- The fenderwell trims are identified by a label attached to the inside surface.

Installing the Front Fenderwell Trims

1. Remove the three expansion clips that secure the right inner fender.

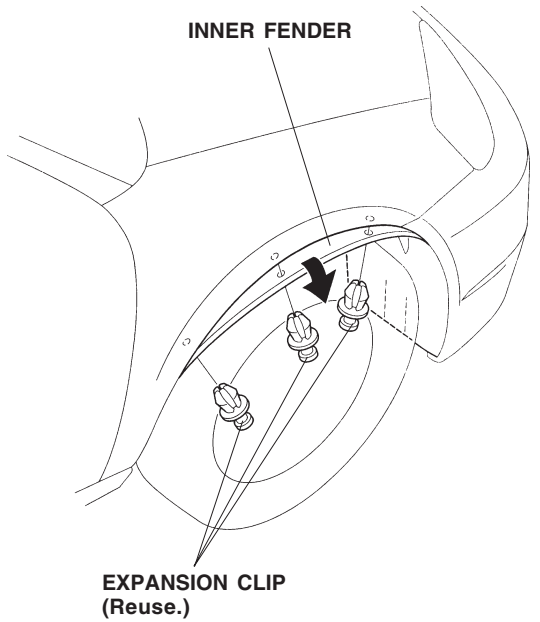

2. Clean and wax the area to be covered with a high-quality paste wax.

3. Pull down the inner fender, and position the right front fenderwell trim between the inner fender and the fender flange. Align the fenderwell trim with the front bumper as indicated by the arrow.

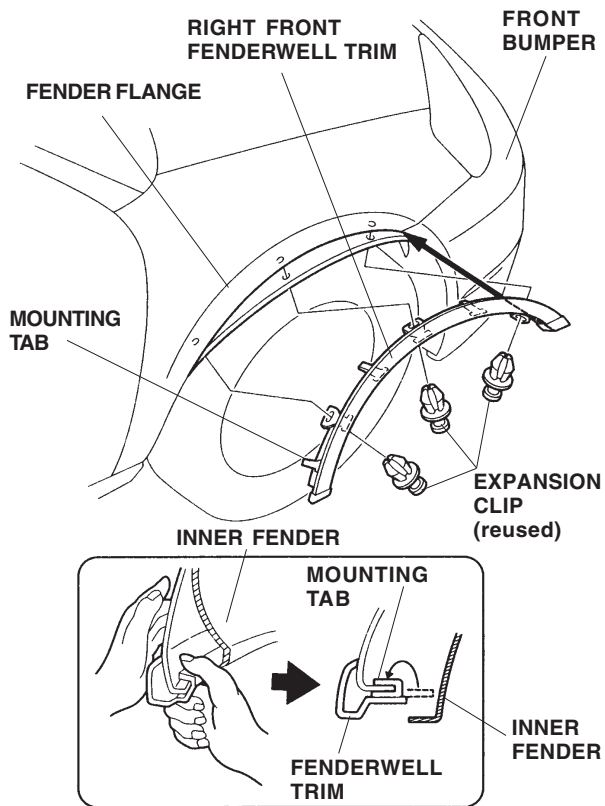

4. While holding the fenderwell trim firmly against the fender, squeeze the two mounting tabs around the fender flange as shown. If necessary, use pliers over a shop towel to bend the mounting tabs around the fender flange.
5. Attach the front of the fenderwell trim and the inner fender to the front fender with three expansion clips removed in step 1.
6. Repeat steps 1 through 5 to install the left front fenderwell trim.

Installing the Rear Fenderwell Trims

7. Position the right rear fenderwell trim on the fender flange, and align the rear of the fenderwell trim with the rear bumper. Hold the fenderwell trim firmly against the fender; then bend the six mounting tabs around the fender flange.

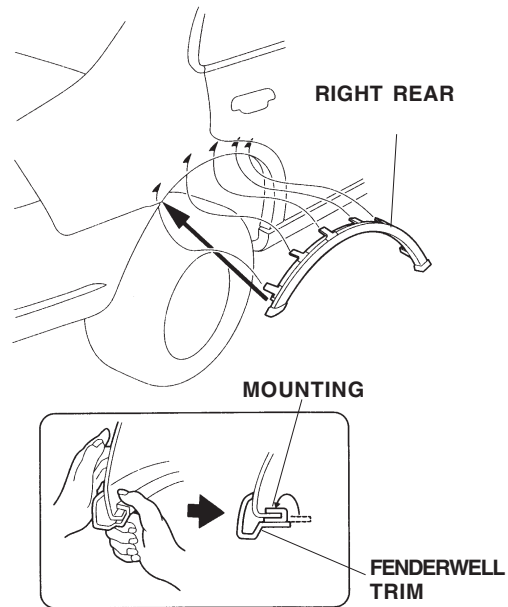

8. Drive the inner protector over the fender flange and fenderwell trim using a rubber mallet.

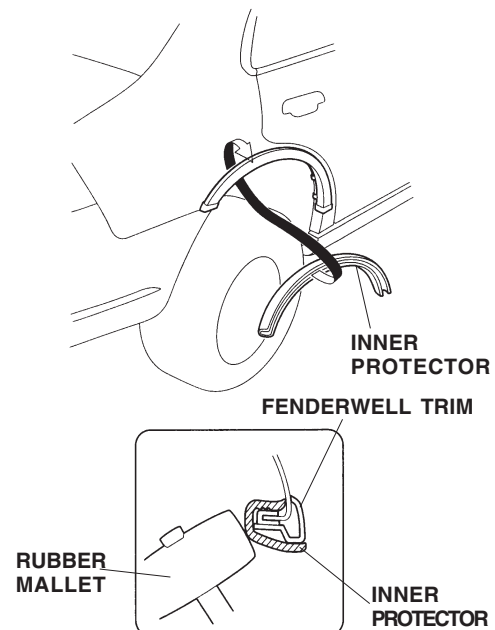

9. Repeat steps 7 and 8 to install the left rear fenderwell trim.